



Manganese Dioxide Lithium Battery

CR2032

Diagrams of Batteries with Terminals

Horizontal & Through hole Type

● External Dimensions (unit: mm)

CR2032 T6	CR2032 T6LES	CR2032 T14	CR2032 T15	CR2032 T16
		<div data-bbox="1454 1060 1721 1249" style="border: 1px solid black; padding: 5px; text-align: center;"> <p>Actual appearance</p> </div>		
		<div data-bbox="1454 1858 1721 2047" style="border: 1px solid black; padding: 5px; text-align: center;"> <p>Actual appearance</p> </div>		

Tin plating



Manganese Dioxide Lithium Battery

maxell

CR2032 (210mAh)

Diagrams of Batteries with Terminals

Horizontal & Surface mounting Type

● External Dimensions (unit: mm)

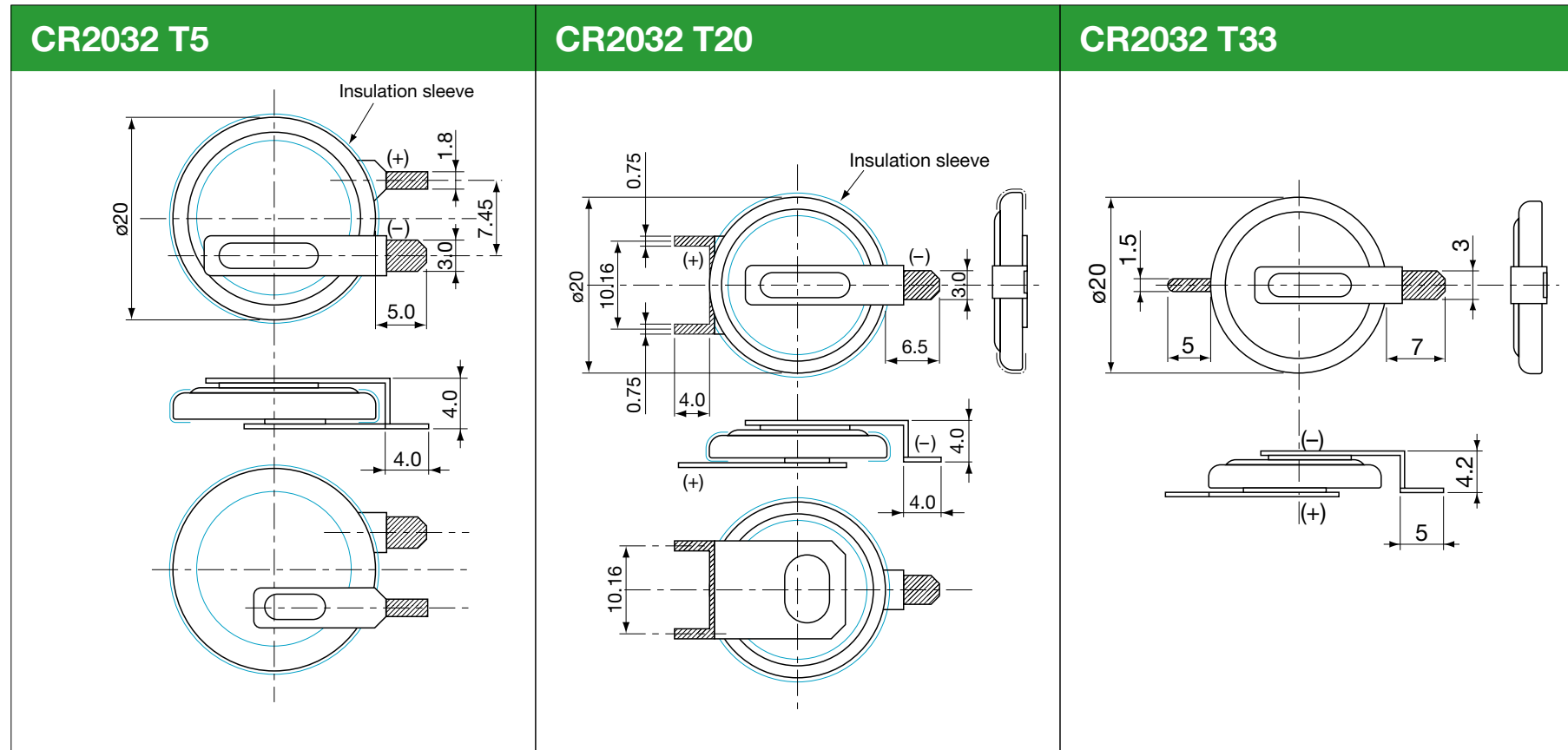

Tin plating



Manganese Dioxide Lithium Battery

maxell

CR2032 (210mAh)

Diagrams of Batteries with Terminals

Vertical & Through hole Type

External Dimensions (unit: mm)

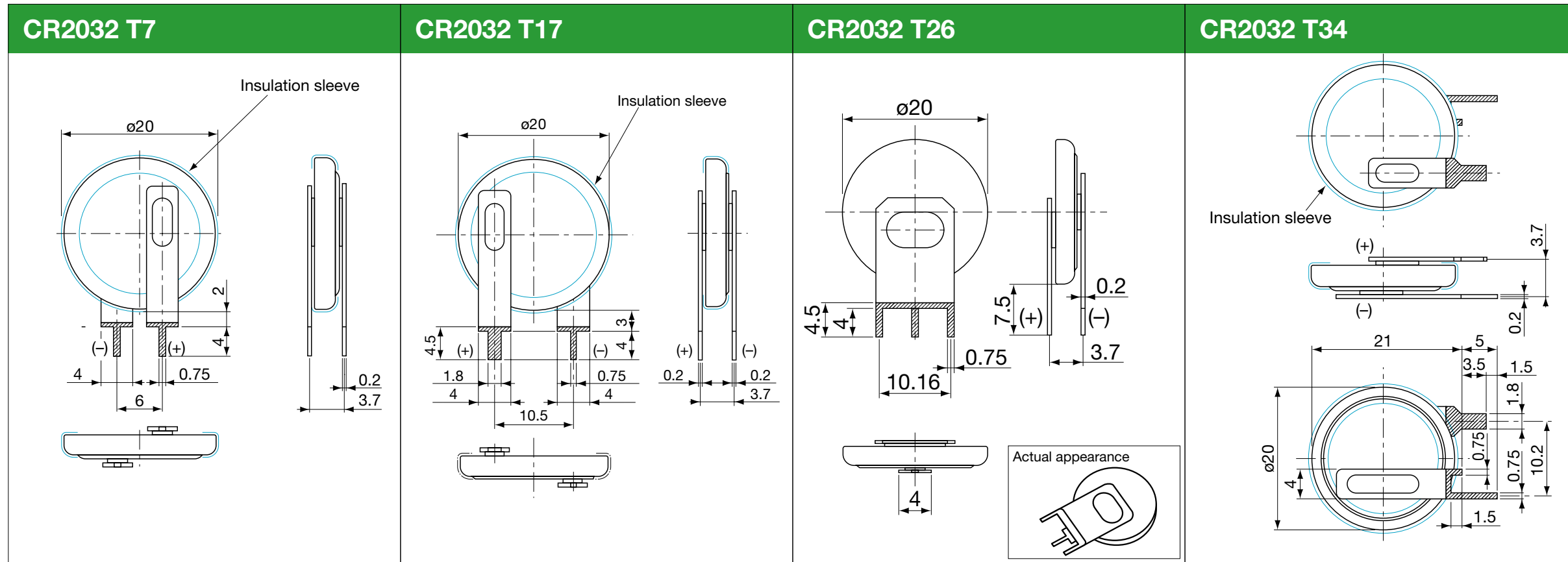

Tin plating



Manganese Dioxide Lithium Battery

CR2032

Diagrams of Batteries with Terminals

Wire connector Type

● External Dimensions (unit: mm)

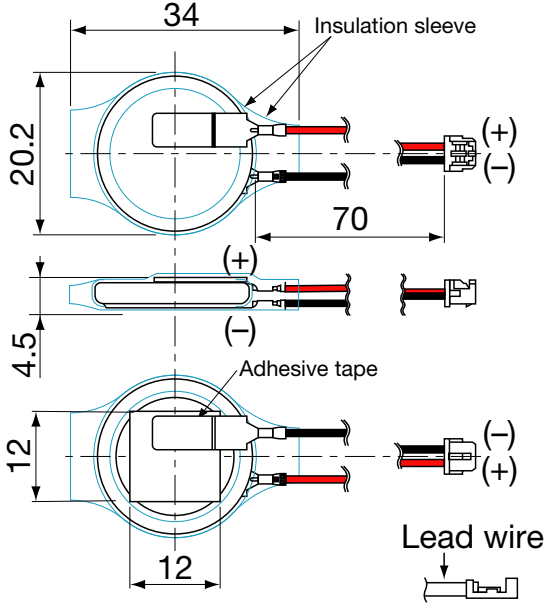
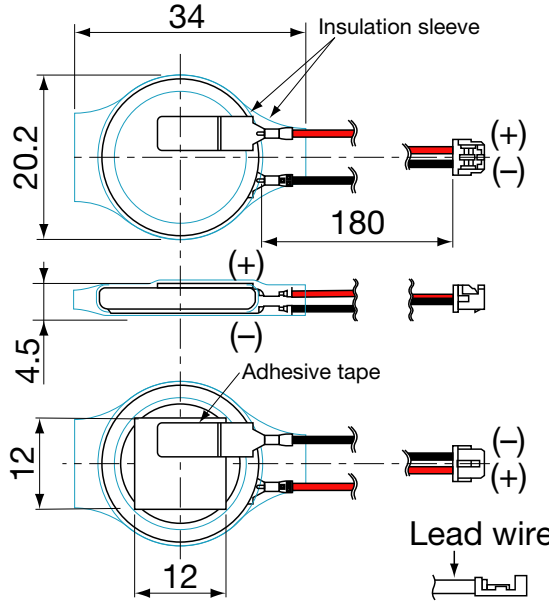
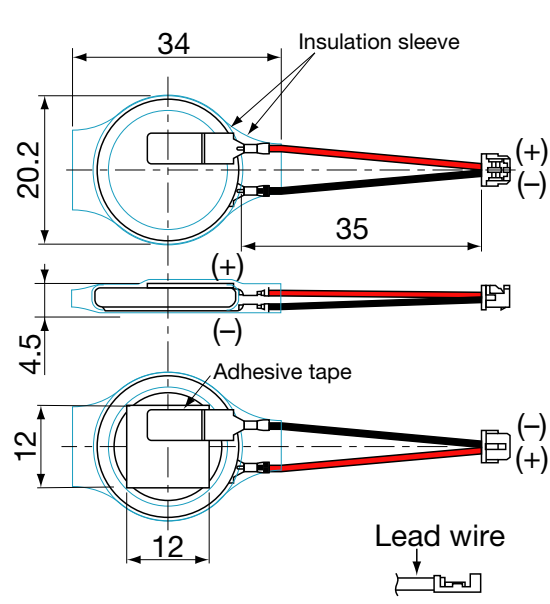
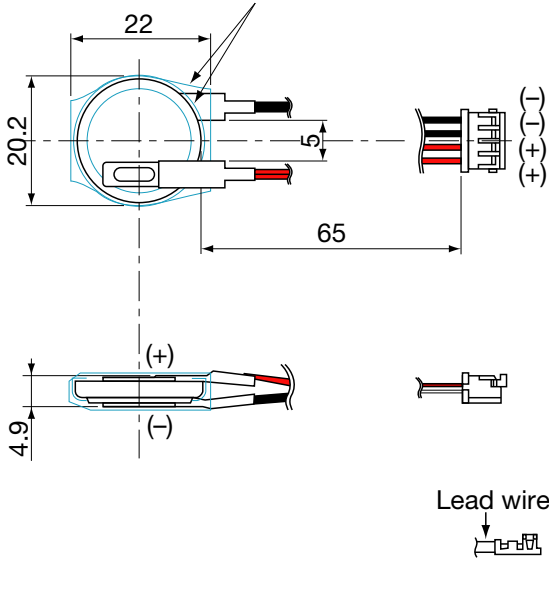
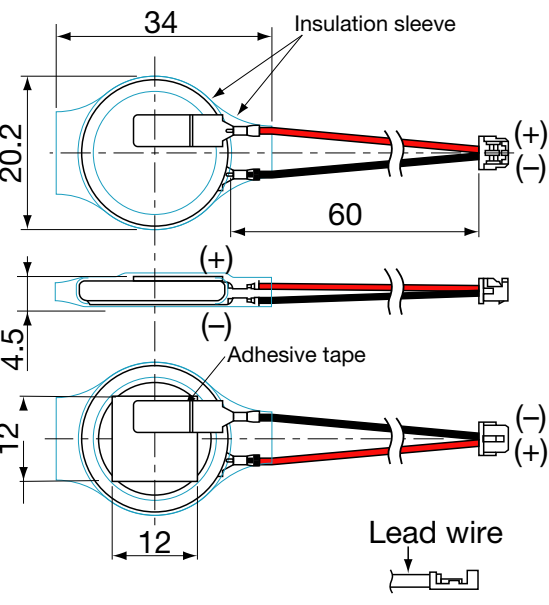
CR2032 WK11	CR2032 WK12	CR2032 WK13	CR2032 WK14
 <p>Housing: DF13-2S-1.25C (Hirose) Contact: DF13-2630SCF (Hirose) Wire: AWG28</p>	 <p>Housing: DF13-2S-1.25C (Hirose) Contact: DF13-2630SCF (Hirose) Wire: AWG28</p>	 <p>Housing: DF13-2S-1.25C (Hirose) Contact: DF13-2630SCF (Hirose) Wire: AWG28</p>	 <p>Housing: DF3-4S-2C (Hirose) Contact: DF3-2428SCF (Hirose) Wire: AWG28</p>
CR2032 WK15			
 <p>Housing: DF13-2S-1.25C (Hirose) Contact: DF13-2630SCF (Hirose) Wire: AWG28</p>			